

**START HERE** The ZROADZ Series Grilles comes into 2 different configurations. One style features the LED Light Bar mounting hidden on the backside, while the other style has exposed mounting provisions on the face side of the grille. Please note this and identify your ZROADZ Grille Series configuration and follow the instruction version that corresponds with your grille.

**GRILLE CONFIGURATION STYLE 1**

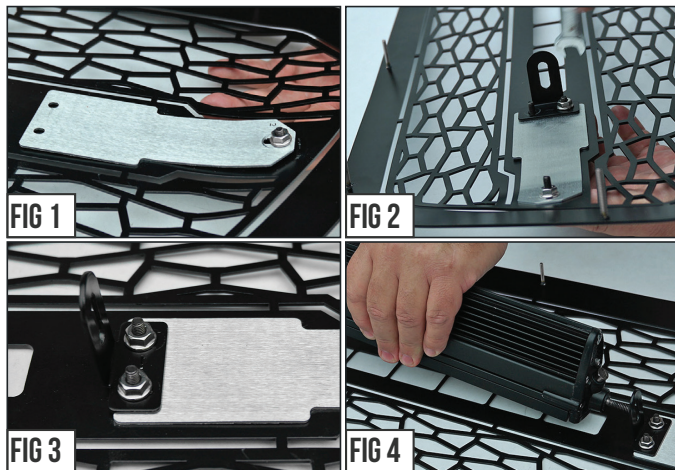

**STEP 1** Lay out your parts. From the backside of the grille, put into place the ZROADZ Logo Backing Plate.



**STEP 2** Put into place one of the Bracket Tabs and secure with provided Hardware as seen in Fig. # 2-4 and then from the backside of grille position LED Light Bar.

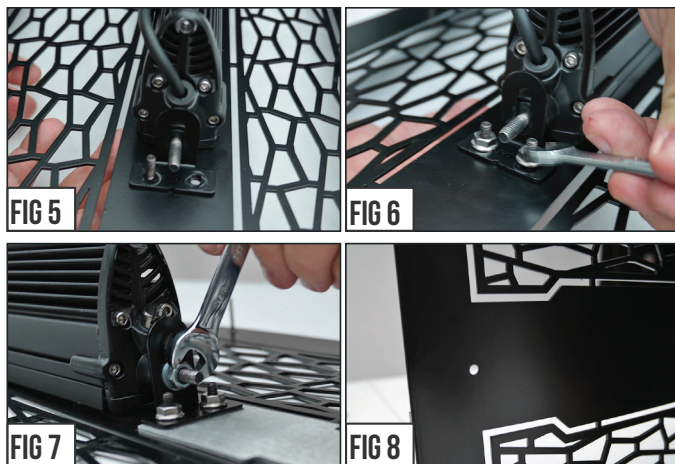

**STEP 3** With LED Light placement set, put into position the remaining bracket and the finally tighten LED and all Mounting Brackets into their final secured position.

**GRILLE CONFIGURATION STYLE 2**

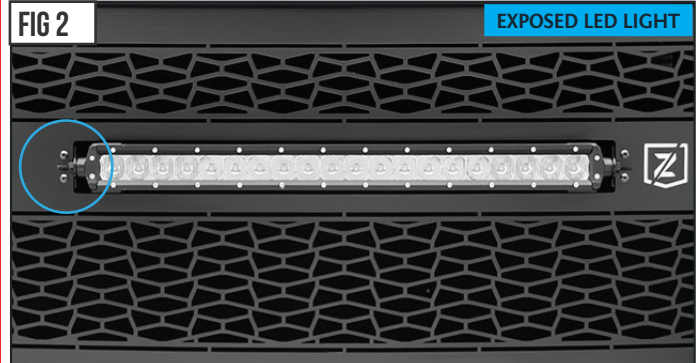

**STEP 1** Lay out your parts. From the backside of the grille, put into place the ZROADZ Logo Backing Plate.

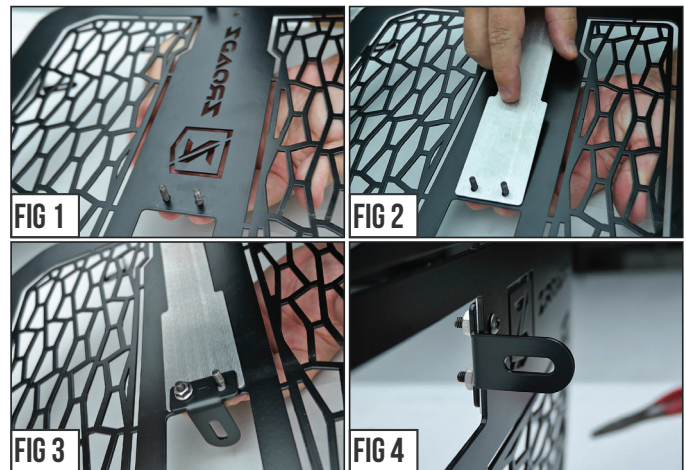

**STEP 2** Put into place one of the Bracket Tabs and secure with provided Hardware as seen in Fig. # 1-4.

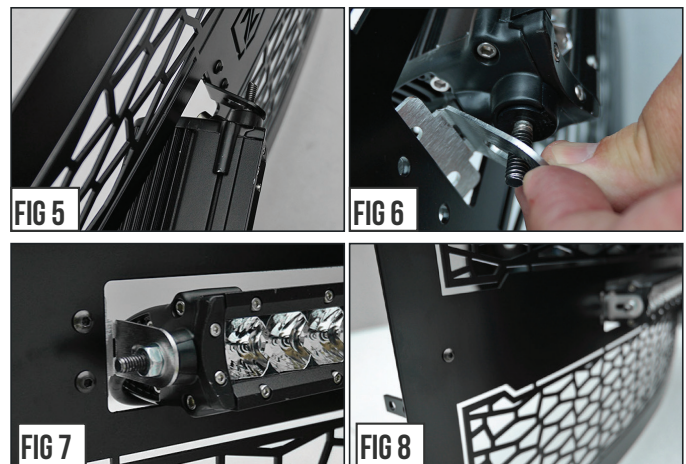

**STEP 3** From the face side of grille slip the LED Light bar into place. On the opposite side, position the remaining bracket and finally tighten LED and Brackets into position.

**STEP 4** There is a final step for both styles of ZROADZ Grilles. See both of the Figure #8 Images and note that there is an exposed hole. Use the Provided Hardware Button Head Screw and fill the hole and tightened down with Nut. This will create symmetrical look from side to side.

**GRILLE ASSEMBLY - COMPLETE**

# T-REX

## GRILLES



## ZROADZ SERIES GRILLE

MAIN GRILLE REPLACEMENT #Z314551

2017 DODGE RAM REBEL 1500

### PARTS INCLUDED

(1) ZROADZ - Main - Grille - Replacement

Part #Z314551 - Black

(1) 20" ZROADZ LED Light Bar  
(1) Military Grade Wiring Harness

### HARDWARE INCLUDED

(2) - 5" Brackets  
(2) - Black Fasteners  
(2) - 10-32 Flange Nuts  
(2) - Push Retainer Clips  
(1) - Security Torx Bit

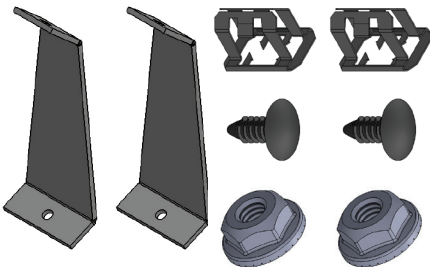

### TOOLS REQUIRED

- Flash Light
- Socket Set & Ratchet Tool
- Long Extension
- Screwdriver set
- Needle Nose Pliers
- 1/2" Plastic Spatula

### GRILLE REMOVAL & GRILLE INSTALLATION GUIDE

#### START HERE

PLEASE READ AND UNDERSTAND ALL INSTRUCTIONS BEFORE INSTALLATION. Auto makers offer varied models to each vehicle and occasionally manufacture more than one body style of the same model. To assure your part is correct; our tech department can be contacted at [tech@trexbillet.com](mailto:tech@trexbillet.com) to verify fitment and assist with technical questions. All other inquires can be directed to [info@trexbillet.com](mailto:info@trexbillet.com). In the event you do not have internet access please call 1-800-287-5900.

\* APPLICATION MODELS VARY. WE RECOMMEND TO VERIFY FITMENT BEFORE BEGINNING INSTALLATION PROCESS.  
\* IMAGES FEATURED IN THE INSTRUCTION DOCUMENTS MAY NOT ALWAYS EXACTLY MATCH YOUR GRILL.

#### STEP 1 FRONT BUMPER REMOVAL

1) Turn off engine and chalk tires with stop block. Open Hood. Disconnect Battery.

#### PRO TIP:

Before you begin, use "3M Painters Tape" to apply a protective guard around the work areas. Attend to the fender and bumper valance. This will help protect the paint and finish of your vehicle.

This is a grille replacement and use OEM factory grille mounts.

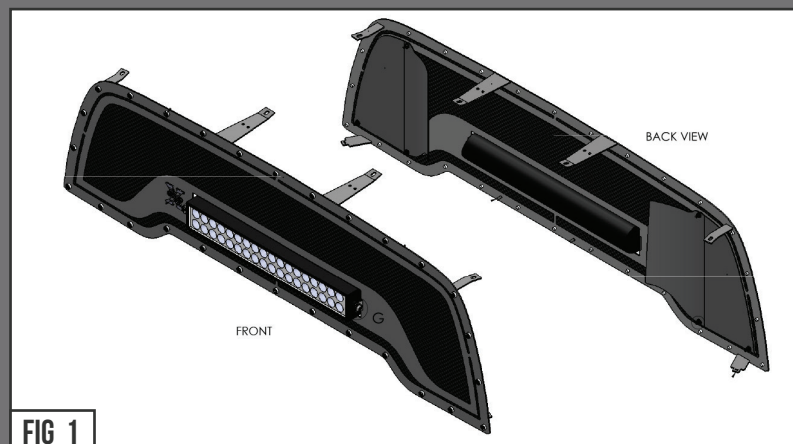

FIG 1

#### STEP 2

2) Lay out all the supplied parts and provided hardware.

# ZROADZ SERIES GRILLE

## MAIN GRILLE REPLACEMENT #Z314551

### 2017 DODGE RAM REBEL 1500

#### GRILLE REMOVAL - START



#### STEP 3

SEE FIGURES 3 - 5

3) Prepare to remove the OEM Grille by removing the top radiator shroud piece.

This will allow to access the fasteners that secure the OEM Grille.



#### STEP 4

SEE FIGURES 6 - 8

4) Using a socket and a long extension remove the bolt in the lower corners mounting points. You may need a Flash Light to identify these bolts.

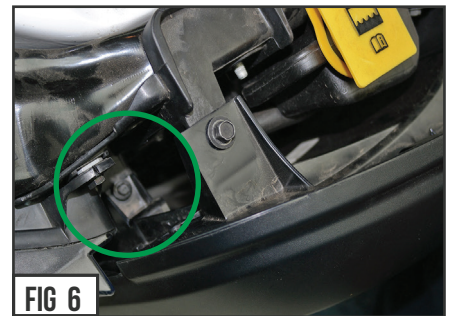

#### STEP 5

SEE FIGURES 8 & 9

5) With the lower corner bolts removed, move up to the (4) bolts along the top.

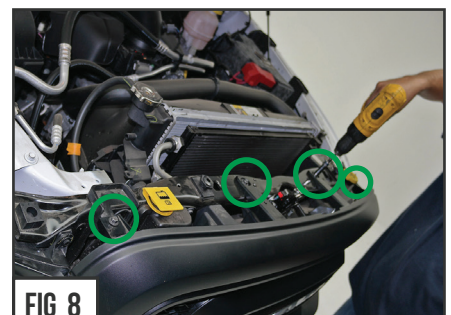

# ZROADZ SERIES GRILLE

## MAIN GRILLE REPLACEMENT #Z314551

### 2017 DODGE RAM REBEL 1500

#### GRILLE REMOVAL-CONTINUED



#### STEP 6

SEE FIGURES 10 & 11

6) The OEM Grille should now be free to be removed from nose of vehicle. Set aside OEM Grille.



#### STEP 7

SEE FIGURE 17 & 18

7) Take the new T-REX Grille Replacement and put into place the (2) Push Retainer Clips onto the grille's pre-determined mounting tabs.

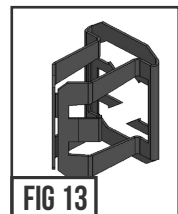

FIG 13  
Push Retainer Clips



FIG 14  
Black Fasteners

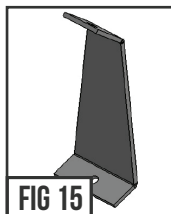

FIG 15  
5" Brackets

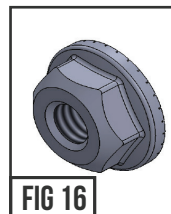

FIG 16  
10-32 Flange Nuts

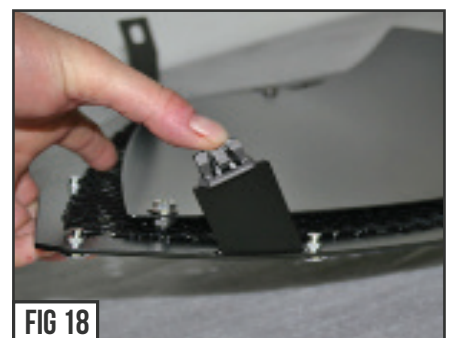

FIG 21



FIG 20

#### STEP 8

SEE FIGURES 19 - 21

8) Put into place the (2) 5" Brackets and using the (2) 10-32 Flange Nuts, fix the 5" Brackets to the new T-REX Grille Replacement. There are (2) threaded studs that will properly locate them into position. Note Figure #21 for the correct orientation.

#### GRILLE ASSEMBLY - COMPLETE

# ZROADZ SERIES GRILLE

## MAIN GRILLE REPLACEMENT #Z314551

### 2017 DODGE RAM REBEL 1500

#### GRILLE INSTALL - START

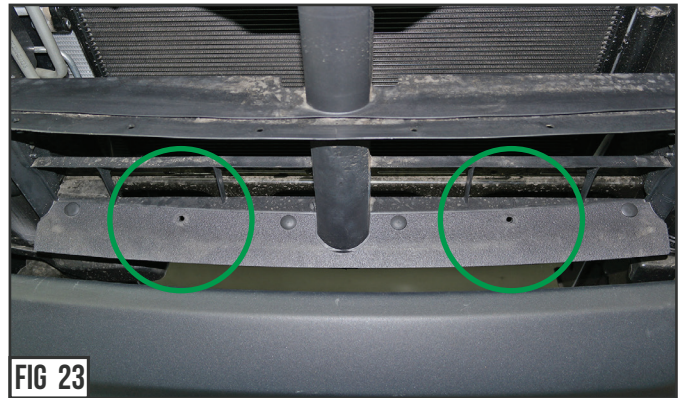
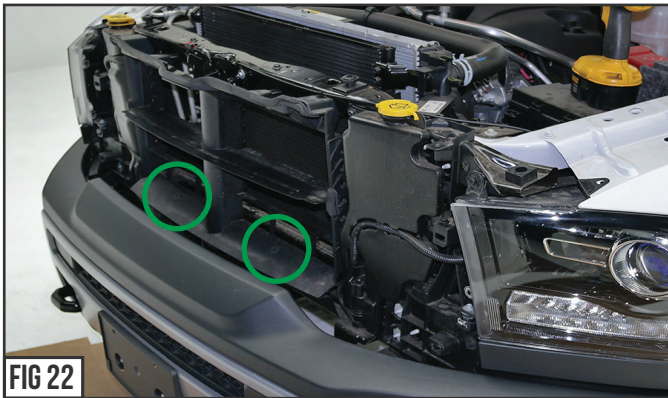

#### STEP 9

SEE FIGURES 22 - 24

9) Using the provided (2) Black Plastic Fasteners and press them into place through the (2) 5" Brackets pre-determined mounting holes as indicated in Figure #24.

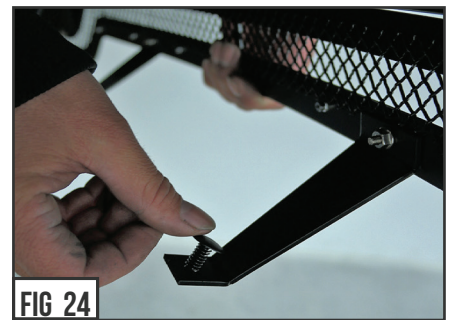

#### STEP 10

SEE FIGURES 22 - 26

10) It is now time to mate up and install the new T-REX Grille Replacement over and onto the nose of the vehicle. Start by aligning the Black Plastic Fasteners with the holes on the vehicle's lower radiator shroud highlighted in Figure #22 and #23.



#### STEP 11

SEE FIGURE 27 & 28

11) Carefully put into position and align the lower corners of the new T-REX Grille Replacement so that the installed Push Retainer Clips will mate with the fastener receptacle as seen in Figure #27.

Once aligned on the inside, give the grille's outside face a firm push so that the Push Retainer Clips will securely latch into place.

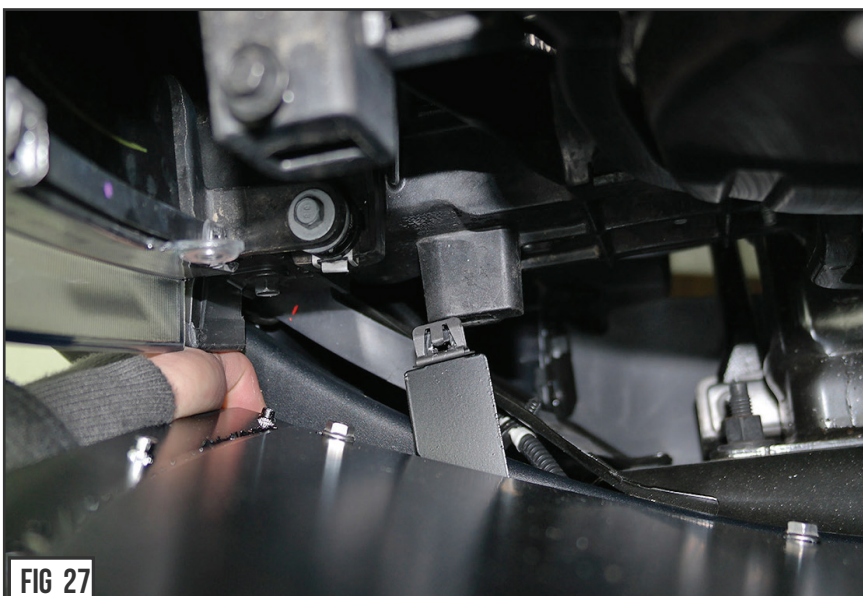

# ZROADZ SERIES GRILLE

MAIN GRILLE REPLACEMENT #Z314551

2017 DODGE RAM REBEL 1500

## INSPECT YOUR WORK



### STEP 12

12) Finally re-install OEM hardware that was removed back in Step #5 and secure the new T-REX Replacement Grille in place.

## GRILLE INSTALL - COMPLETE

### STEP 13

SEE FIGURES 17 - 19

13) At this point you want to look over your work and examine the gap alignments around all edges and in between the new T-REX Grille and the vehicle components and body lines. Carefully close the hood for a complete visual inspection. If adjustment is needed, you can remove grille and loosen the hardware mounts and shift side to side or up & down to achieve proper look.



FIG 31



## T-REX GRILLES PRODUCT WARRANTY

### T-REX GRILLES PRODUCT WARRANTY

T-REX Truck Products warrants its grille products to be free from defects in material and workmanship for the lifetime of the grille. T-REX Truck Products warrants the finish of its grille products for a 3 year period beginning at the time of sale to the end user. These warranties are limited warranties and do not cover abuse, modification or improper installation nor do they cover finish failure caused by caustic cleaning agents, road salts or other chemicals. T-REX Truck Products reserves the right to repair or replace a defective product at its sole discretion. Any T-REX product must be returned to T-REX for warranty consideration and must be returned at the customer's expense. In the event that the product is deemed to be defective, the repaired or replaced item will be returned via a surface shipping method to the customer at T-REX Truck Products expense. No provision is made for any labor, rental car or other costs incurred by the failure of its products.

## LED LIGHTING EQUIPMENT INSTALLATION / DISCLAIMER

### WARNING

**PLEASE CONSULT YOUR LOCAL AUTOMOTIVE ELECTRICAL PROFESSIONAL FOR INSTALLATION SERVICES AND ADVICE.** T-REX IS ONLY EQUIPPED TO PROVIDE BASIC TECHNICAL ASSISTANCE DUE TO THE DIVERSITY OF VEHICLES, VEHICLE OPTIONS & MODIFICATIONS AND LIGHTING CONFIGURATION OPTIONS AVAILABLE. T-REX Truck Products cannot be held liable due to improper component installation and / or faulty wiring.

### GENERAL GUIDELINES

LED Lights & LED Light Bars operate at relatively high currents and should only be installed by qualified personnel with experience in switched / relayed high draw DC Circuits.

- Light Bars are designed for use only with standard 12v DC power systems
- Light Bars are for OFF-ROAD USE ONLY. Check your local laws & regulations regarding vehicle mounted lights.
- Some Light Bars are equipped with waterproof connectors while others are simply pig-tailed
- Red Wires = POSITIVE | Black Wires = NEGATIVE
- ALWAYS install your lights on a fused circuit. Basic fusing guidelines: maximum 5A for every 10" of LED Light Bar.

### GENERAL USE, INSTALL AND ADJUSTMENT TIPS

NOTE 1: T-REX Torch Series Grilles (with LED Light Bars installed), and LED Light Bars themselves are for OFF-ROAD USE ONLY.

NOTE 2: Light Bars in Torch Series Grilles are installed flush with the grille from the factory. This may or may not be the ideal angle for each light depending on the configuration of your vehicle and its options and/or modifications. To adjust the angle of your light bars simply loosen the mounting hardware on either side of each Light Bar, rotate the Light Bar to adjust the angle, then tighten the hardware once the desired angle is achieved (please be careful not to over-tighten the mounting hardware or scratch the protective powder-coat finish). It is best to adjust the angle with the vehicle on level ground with the lights facing a wall, garage door or other solid barrier at a distance of approximately 25-30 feet.

NOTE 3: Please consult a qualified automotive electrical professional for light bar wiring installation.

NOTE 4: An optional universal wiring harness (part# 639HAR1) is also available that includes high-heat & oil/fuel resistant wires, waterproof connector, 12v relay, 12v rocker switch, inline fuse holder. Our universal wiring harness significantly expedites the installation process but is not a vehicles specific "Plug & Play" product and does not eliminate the need for a professional installation.

Please contact your local T-REX dealer for more information or visit [www.trexbilliet.com](http://www.trexbilliet.com).

## GRILLE CARE INFORMATION

### GRILLE CARE INFORMATION

T-REX grilles are finest in the industry but do require normal care. Wash regularly as you would when caring for your vehicles. Never use dish soap.

### POLISHED FINISH

T-REX polished grilles should be waxed at the same time that you wax the vehicle and can be cleaned with soap and water. A polished finish can be cared for in the same fashion that would care for your vehicles factory chrome. Never leave wet water spots as that may leave a blemish.

### MATTE BLACK FINISH

Paint warranty applies to defects in material and / or workmanship, it does not cover the matte finish surface appearance.

To enjoy the matte appearance for many years to come, please follow these owner care and maintenance tips.

Get a no-shine matte car wash soap that uses no fillers, no silicone, and won't strip your matte paint of its layer of protection.

Do not use wax, detail spray, armorall®, or any products made for normal paint. Use only products specifically developed for matte finish paint. Do not use products that are even mildly abrasive, such as polishes, glazes, or rubbing compounds. Do not use mechanical cleaners or polishers. Do not use terrycloth, cloth, or paper towels. Do not rub the finish vigorously, this will burnish the paint finish, causing a permanent shiny spot. Shiny spots cannot be removed.

Do not use commercial car wash facilities or their shine enhancement products. Most car wash brushes, large mechanized "towels," and shine enhancement products can damage matte paint.

Remove foreign substances such as insect remains, tar, and road debris using a soft applicator and a mild solvent; saturate and soak area before cleaning—rub lightly.

Hand-wash with a soft wash mitt and mild cleaning product safe for matte paint. Use microfiber cleaning cloths with alcohol-based window cleaner for basic surface clean-up.

### GLOSS BLACK FINISH

T-REX Grilles with Gloss Black Powder Coated Finish may be washed regularly as you would when caring for your vehicles finish using soap and water. T-REX grilles should be waxed at the same time that you wax the vehicle. As a general rule, anything you use to clean your vehicles painted surfaces can be used to clean and maintain your T-REX grille. A Gloss powder Coated Finish can be cared for in the same fashion that you would care for your vehicles factory paint job. Never leave wet water spots as that may leave a blemish.